

Mevo+



User Manual



Performance data you can trust

"FlightScope technology is developed to offer you performance data you can trust in your pursuit of excellence."

A handwritten signature in black ink, appearing to read "H. Johnson".

Henri Johnson - Founder & CEO

Contents

Battery Warning	1	Tips	19
Performance tracking	2	Indoor ball spin	20
In the box	3	Tee the ball	21
Mevo+	4	E6 Connect	22
Charging	5	Switch off	23
Battery indicators	6	Electronic noise	24
System indicators	8	Care	27
Get the app	9	Avoid	28
Connect to Mevo+	10	FAQ's and support	29
Via QR Code	10	Technical specifications	31
Manually (via Wi-Fi)	12	FCC Statement	33
Kickstand	13		
Setup	14		
Setback	14		
Aiming	15		
Clearance	16		

Battery warning



CAUTION: This device contains a Li-ion battery. Do not expose to temperatures below freezing point. Do not expose to excessive heat. Avoid physical impact, puncture, crushing or dropping. **If the unit is struck by a club or ball, a short circuit or other heat reaction may occur, resulting in a fire.**

Do not tamper with the battery pack. Avoid physical damage or stress when removing or inserting the battery. Do not short-circuit the battery terminals. Maintain battery condition by charging and discharging regularly, at least every few months.

Use only the included charger and charging cable for best results. If the battery bulges, emits fumes, or becomes very hot, disconnect it from the charger and replace the battery. Dispose of old batteries in accordance with applicable waste battery and recycling regulations.

Performance tracking

Visit myFlightScope.com to analyze and track your data performance over time.

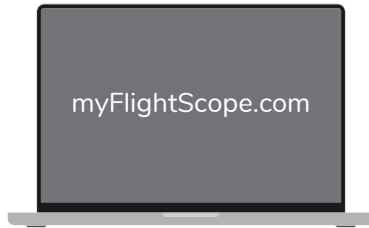

Join the myFlightScope.com community and connect with fellow golfers like yourself. Keep track of your stats over time, spot trends or tendencies and see how you have improved.

Please share your results and tag us on social media.



In the box

- 1 Mevo+
- 2 Case (Not to scale)
- 3 Quickstart guide
- 4 Power adapter
- 5 USB charging cable
- 6 Aluminum stickers
(Only needed for indoor use)



Mevo+

- 1 Indicators
- 2 USB charging port
- 3 Alignment camera
- 4 On / Off button
- 5 Kickstand
- 6 5000 mAh Battery (under rubber band)
- 7 Tripod mount (bottom of the unit)
- 8 Serial Sticker (includes QR code for connection)

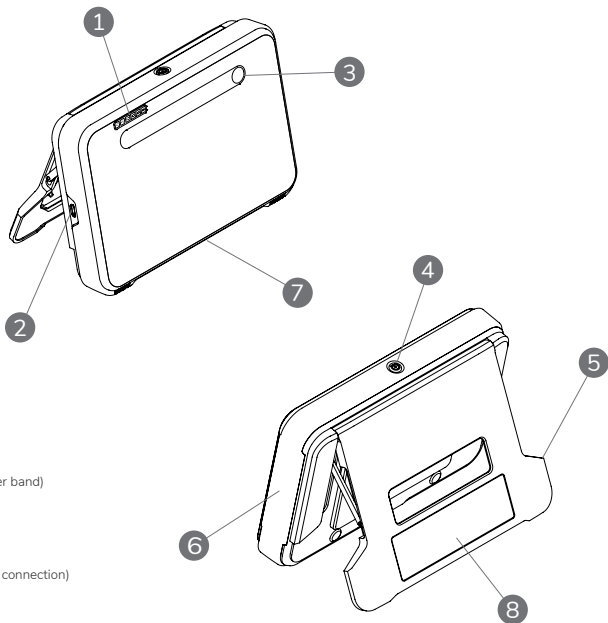

Power and charging

4hrs for a full charge using
the supplied adapter.

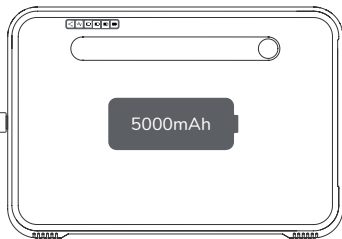

External FlightScope battery packs available
in shop on flightscopemevo.com



Battery and charging indicators



Charging error

(Battery too hot or cold to charge,
or battery is not connected properly)

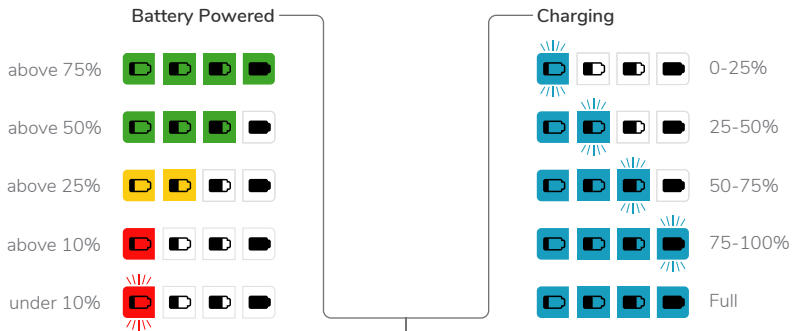

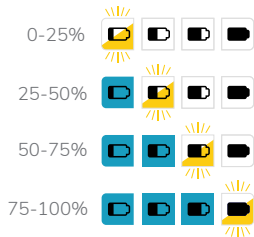

Externally Powered (Battery not charging)



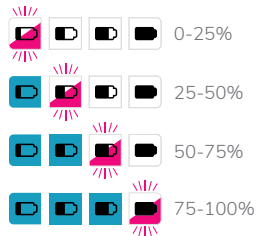







External & battery power (External power is not sufficient to power system)



System indicators

- Connection Status**
- Ready 
 - Connected 
 - Communication Error 

Radar Status

-  Power on, switching on
-  Processor start up 30-60 seconds
-  Standby mode
-  Armed, ready to measure
-  Triggered
-  Sleep
-  Processor shut down 15-30 seconds
-  Battery empty
-  Firmware error



Get the app

Download and install the **FS Golf** app.

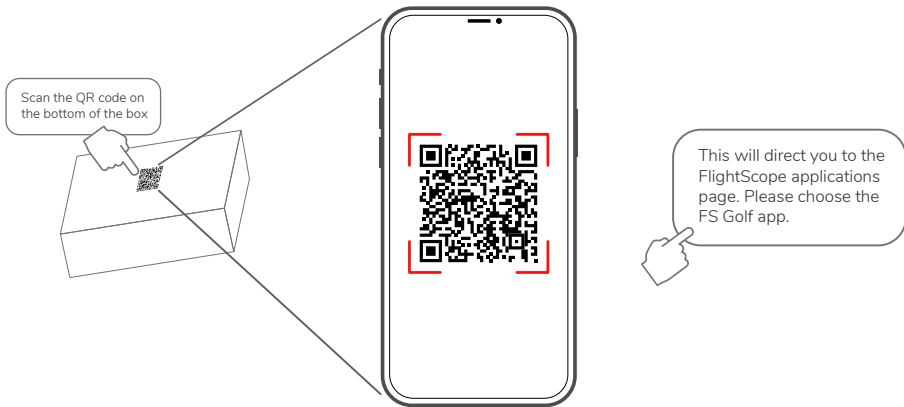

Connect to Mevo+ (via QR Code)

1



Wi-Fi on

2

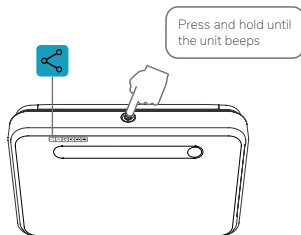

Switch on

3



Launch FS Golf app

The username and password you setup will be the same for **myflightscope.com**

4

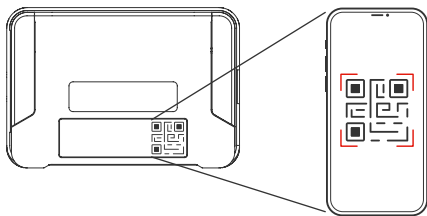

In app, scan QR code
on back of unit



5

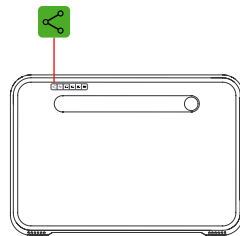

Connected

Connect manually (via Wi-Fi)

If you are unable to connect using the QR code, then you can connect manually in your device settings. Follow these easy steps:

- 1 Make sure your phone's Wi-Fi is turned on.
- 2 Press the on/off button on the unit, the system and battery lights will come on. The connection light will be solid blue while the unit is ready for connection.
- 3 Select Wi-Fi settings on your phone and select the unit with your serial number. The Wi-Fi password is your serial number, for example: M2-123456.
- 4 The connection light on the the unit will turn to solid green when connection has been established.
- 5 Launch the app on your phone and proceed.

Kickstand

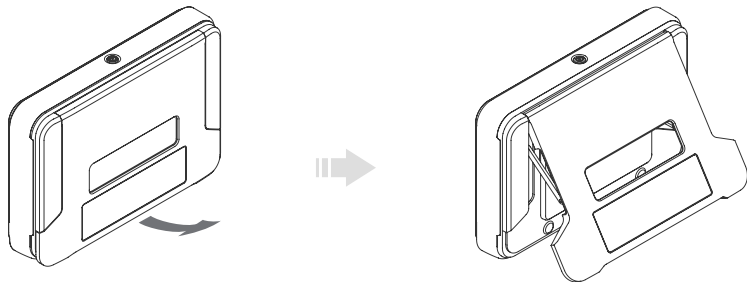

Open the Kickstand before placing.

The kickstand will stop at open position. With the kickstand open, the radar will be at the correct tilt angle on a flat surface.



Do not over extend the kickstand or force it past it's open position, this can cause damage to your unit.

Setup - Setback

OUTDOOR

Aluminum stickers **NOT** required.

Unrestricted
ball flight



7'-9' (2.1m-2.7m)
sensor to tee

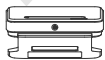

LIMITED FLIGHT

Aluminum stickers **required**.

Aluminum stickers not required if using Titleist RCT golf balls.

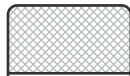

13' (4m) min.



8' (2.4m)
sensor to tee

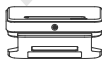

Aiming

- 1 Place the Mevo+ behind the ball position so that the camera aims along the chosen target line.

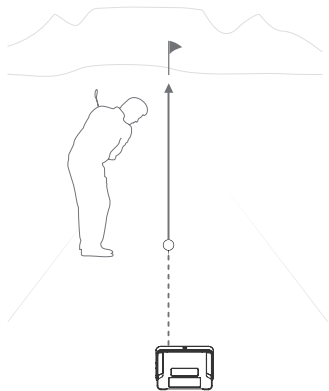

- 2 In the App, follow the instructions using the camera view to align.

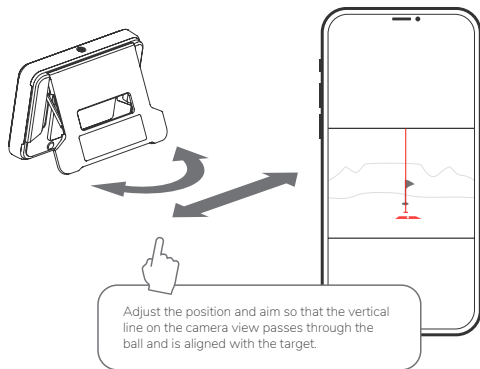

Clearance

Keep area between Mevo+ and the ball position clear of any objects and people.

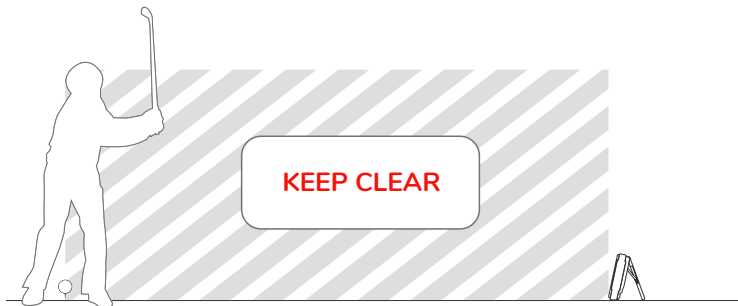

Tips

Best practice is to keep the unit on the floor with a level surface between the unit and the mat.

- ① Hitting Surface
- ② Ground surface
- * Maximum Height: 3" (76mm)

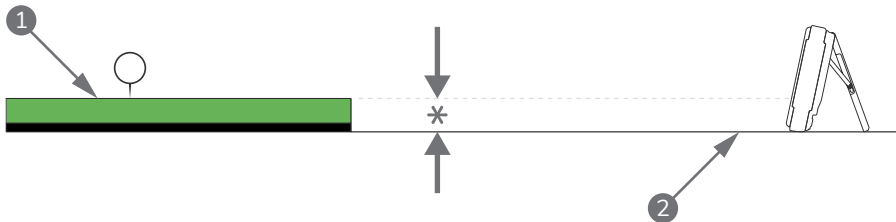

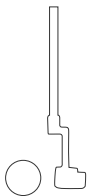

For putting, keep the ball and unit on an even flat surface.

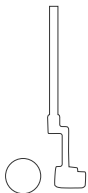

For putting, chipping and hitting never raise the Mevo+ to match the ground level.

Extremely low and wide shots, and shots where the player is between the Mevo+ and the ball, might not register.

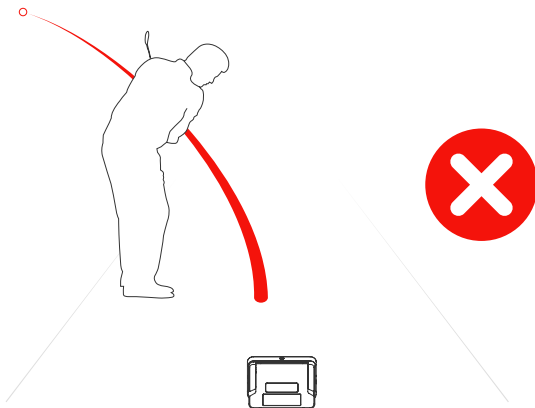

Indoor ball spin

For the best spin accuracy indoors, place a reflective sticker on the ball.



Reflective stickers are for **indoor use** only.

To order additional stickers: go to flightscopemevo.com/collections/mevo-accessories

Tee the ball

Place the ball so that the sticker faces forward, directly away from the Mevo+.

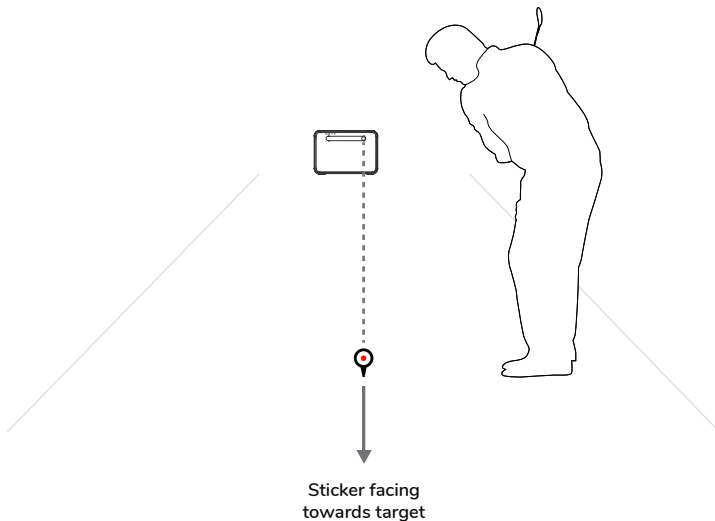

E6 Connect



With your purchase of a new FlightScope Mevo+ 2023 product you receive an E6 Connect golf simulator software license with 10 golf courses, multiple practice ranges, and more features, at no extra charge.

(Note that this free E6 Connect license is not transferable if you decide to sell your Mevo+ to another person in future.)

- 1 Register a **FlightScope Mevo+ account** on the iOS/ Android FS Golf app or Windows FS Golf PC app. An E6 Connect product key will be emailed to you.
- 2 Download the iOS **E6 Connect** app from the Apple app store, or download the Windows PC app from the E6 website at portal.E6golf.com
- 3 Follow the on-screen instructions to create your E6 Connect profile.
- 4 Select the **redeem** option and enter your product key.
- 5 Download the available courses to your E6 Connect app.
(Courses must be downloaded BEFORE connecting your mobile device)
 - **Play Golf Menu > Course Selection**
- 6 You can now connect to your Mevo+ via Wi-Fi and begin your session.

Create or access your account on portal.e6golf.com to activate, view or manage your E6 licenses.

Switch off

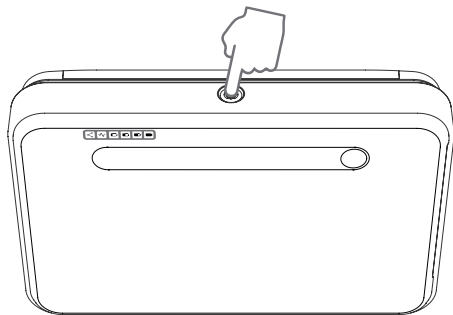

Press and hold to turn off, unit will beep to confirm.
When all indicators are off, the unit is off.

Electronic noise

Mevo+ is designed to operate in most environments. However certain appliances and equipment can create noise that can interfere with resulting shots.

Some common noisy objects are:



aircon



fluorescent
lights



fans



tv's, laptops &
desktop computers
in front of the Mevo+



fridges



signal
towers

Keep area clear of possible noise interference. Make sure to move noisy electronic devices behind the unit.

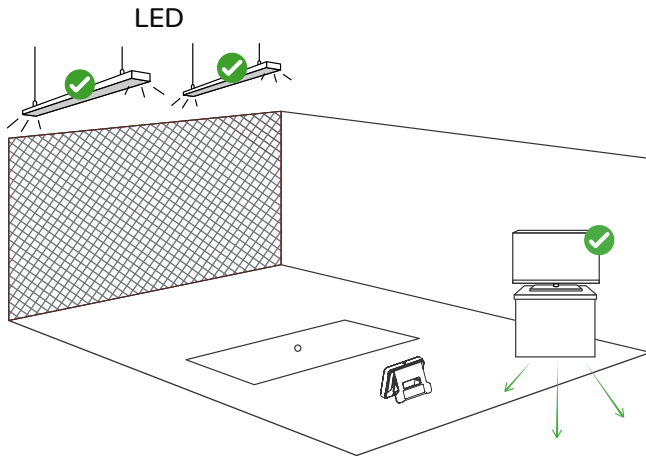

Noisy electronic devices in front of the unit may cause poor tracking performance.

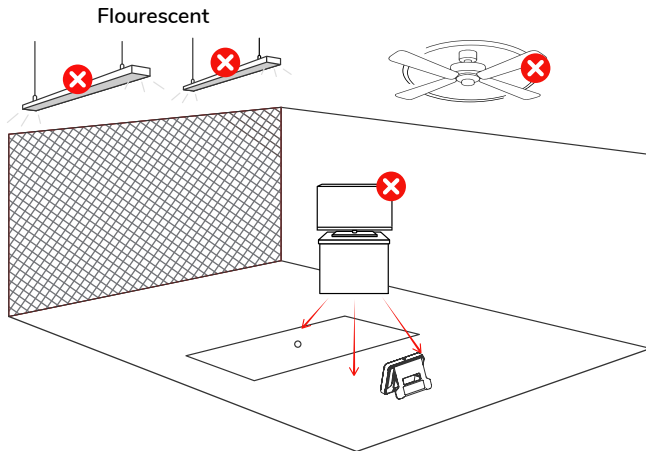

Care

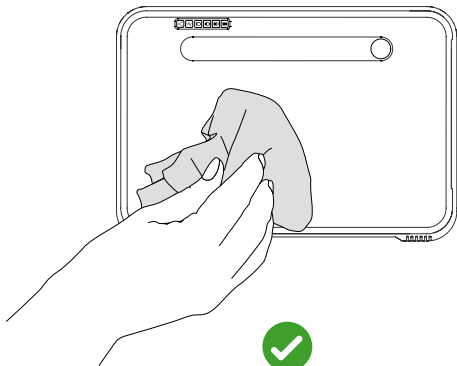

Clean with a damp cloth and light household detergent



Store in the case

Avoid



Moisture, including rain

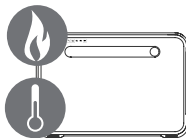

Flames and
direct heat



Physical impact



Excessive weight loading



Water immersion



Solvent Chemicals

FAQ's and support



Below are the top 5 frequently asked questions.
For more FAQ's please refer to flightscopemevo.com/faq

1

1. Can Mevo+ be used indoors and outdoors?

Yes. Please check page 13 for indoor space requirements.

2

2. Does a reflective sticker need to be used?

Yes, for indoor use only. See page 18.

3

3. How is the video recorded?

The video is taken with your iPhone camera in the FS Golf application.

The radar is synchronized with your iPhone to automatically record and clip video of your swing with data overlay.

4

4. Can the built in camera be used for video?

The built in camera is used for target alignment only.

5

5. How long is the battery life?

The battery life is up to 2 hours on a full charge, and up to 1.5 hours in simulator play.



If you need assistance please email our support team at
support@flightscope.com

Technical specifications

transceiver

*operating frequency	24.08 - 24.16 GHz (nominal)
output power (EIRP)	24dBm +/- 3dBm USA 17dBm +/-3dBm EU

* Other frequencies ranges may apply in certain countries

electrical, physical, and general

operating temperature	0°C to 40°C / 32°F to 100°F
dimensions	6.8" x 1.2" x 4.6" / 174 x 31 x 118mm (W x D x H)
mass	1lb / 465g
power supply	5V DC +/- 5%; >2 A
battery	Rechargeable Li-ion Battery, 3.6V, 5000mAh, 18Wh
camera	5MP
data interfaces	USB 2.0

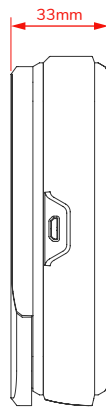
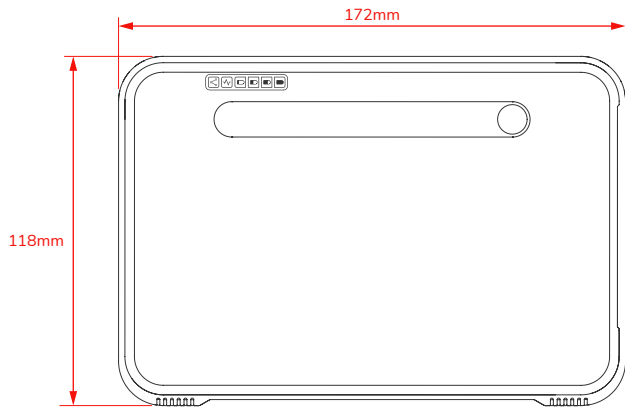

FCC Statement: This equipment has been tested and found to comply with the limits for a Class B digital device, pursuant to Part 15 of the FCC Rules. These limits are designed to provide reasonable protection against harmful interference in a residential installation. This equipment generates, uses and can radiate radio frequency energy and, if not installed and used in accordance with the instructions, may cause harmful interference to radio communications. However, there is no guarantee that interference will not occur in a particular installation. If this equipment does cause harmful interference to radio or television reception, which can be determined by turning the equipment off and on, the user is encouraged to try to correct the interference by one or more of the following measures:

- Reorient or relocate the receiving antenna.
- Increase the separation between the equipment and receiver.
- Connect the equipment into an outlet on a circuit different from that to which the receiver is connected.
- Consult the dealer or an experienced radio/TV technician for help.

Changes or modifications not expressly approved by FlightScope (PTY) could void the user's authority to operate the equipment.

ISED Statement: This device contains licence-exempt transmitters(s)/receiver(s) that comply with Innovation, Science and Economic Development Canada's licence-exempt RSS(s).

Operation is subject to the following two conditions:

- (1) This device may not cause interference.
- (2) This device must accept any interference, including interference that may cause undesired operation of the device.

Declaration IC: Cet appareil contient des émetteurs/récepteurs exemptés de licence conformes à la norme Innovation, Sciences, et Développement économique Canada.

L'exploitation est autorisée aux deux conditions suivantes:

- (1) L'appareil ne doit pas produire de brouillage.
- (2) L'utilisateur de l'appareil doit accepter tout brouillage radioélectrique subi, même si le brouillage est susceptible d'en compromettre le fonctionnement.

Japanese caution: for Indoors use only.

+++++本機器の使用に係る注意事項+++++ 本機器の使用周波数帯（10.5GHzを超え10.55GHz以下の周波数）では、免許を受けて屋外で利用されている無線局があります。これらとの干渉が懸念される為、本機器の使用は、屋内での使用、即ち住宅、マンション、ビル等の建築物内のみと限定されています。万一、10.5GHz帯の周波数を使用する移動体検知センサーを屋外で使用した場合には、その使用に支障が生じるばかりでなく、電波法令に違反し罰則の適用を受けることとなりますので、十分注意してください。

E19-BN276-ISS5



FlightScope[®]

Performance data you can trust

www.flightscope.com